

TYPE 1

- APPLIES TO ALL STATIONS EXCEPT THOSE LISTED IN TYPE 2.

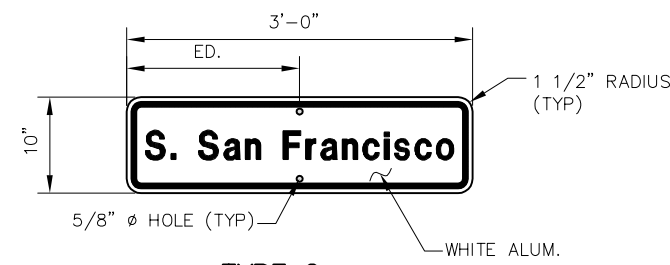

TYPE 2

- APPLIES TO STATIONS:
- MOUNTAIN VIEW
 - CALIFORNIA AVE
 - REDWOOD CITY
 - HAYWARD PARK
 - S. SAN FRANCISCO
 - SAN FRANCISCO

**DETAIL 1
STATION IDENTIFIER**

NOTES:

1. SEE SD-3300 FOR GENERAL REQUIREMENTS
2. STATION IDENTIFIER SHALL BE INSTALLED ON LIGHT POLES. FOR LIGHT POLES LOCATED FARTHER THAN 23 FT FROM CENTERLINE OF TRACK, THE SIGN TEXT SHALL INCREASE BY 1/8 INCH PER FOOT OF DISTANCE GREATER THAN 23 FT

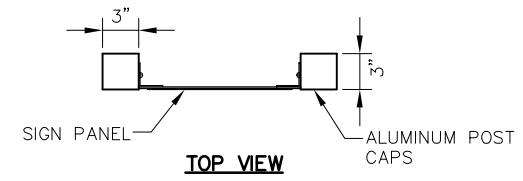

TOP VIEW

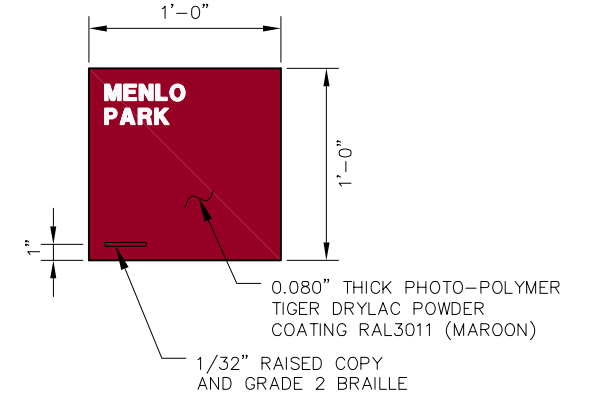

STATION I.D. W/ BRAILLE SIGN

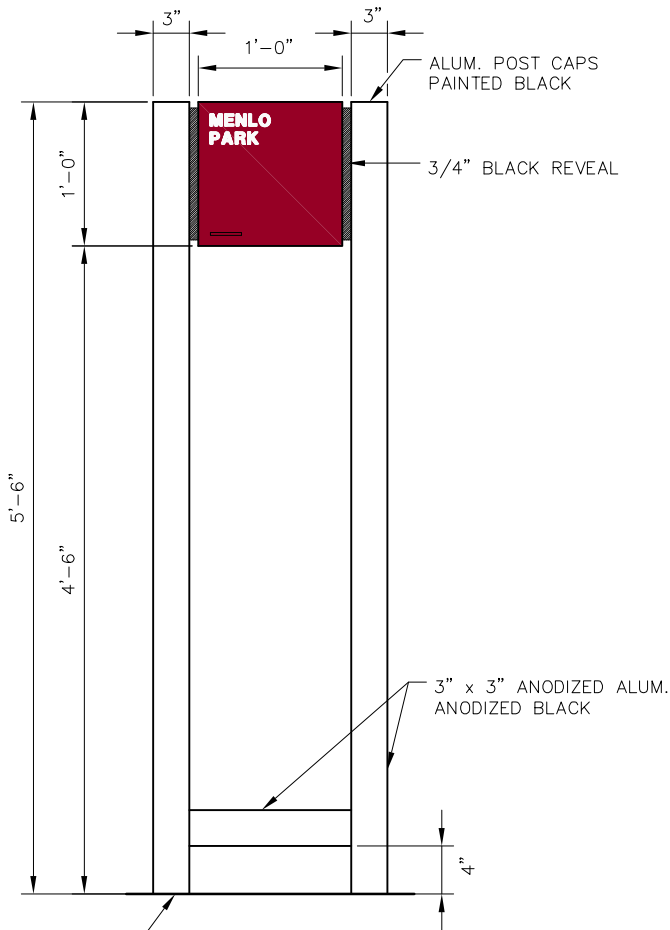

**STATION IDENTIFIER W/ BRAILLE
ON POSTS (ID-2)**

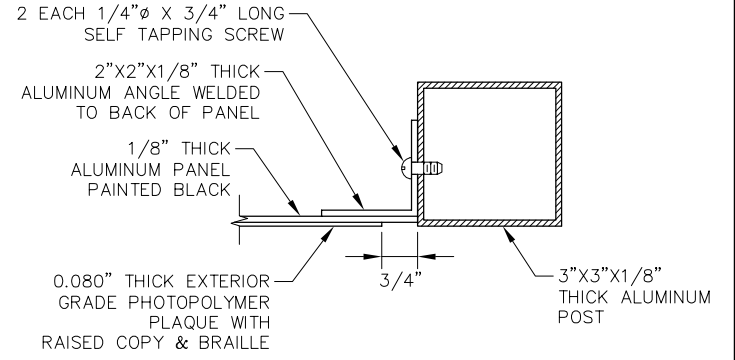

MOUNTING DETAIL

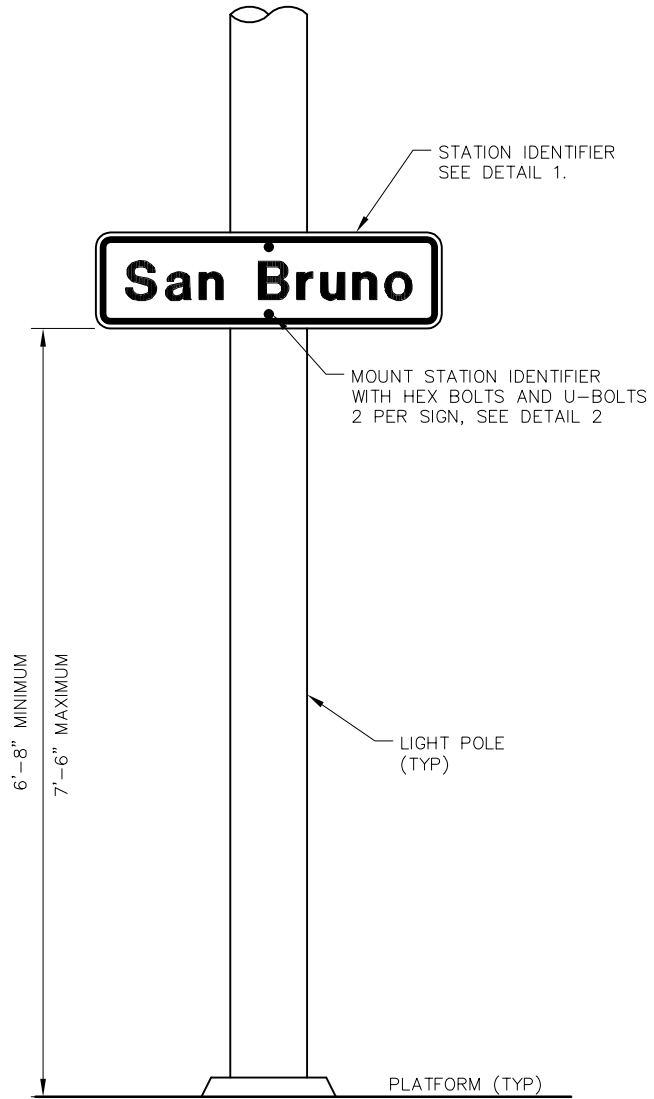

**STATION IDENTIFIER ON LIGHT POLE
(ID-1)**

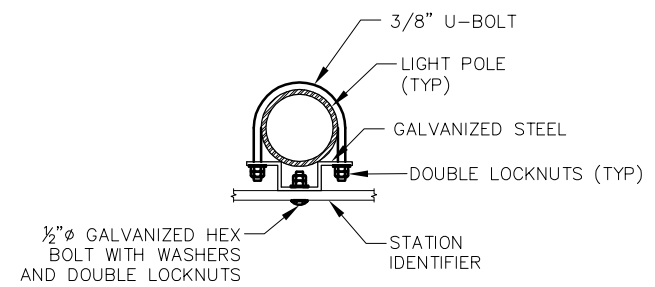

DETAIL 2

REV	DATE	BY	CHK	APP	DESCRIPTION	REV	DATE	BY	CHK	APP	DESCRIPTION

PENINSULA CORRIDOR JOINT POWERS BOARD

APPROVED BY:



ENGINEERING MANAGER DEPUTY DIRECTOR OF ENGINEERING



1250 San Carlos Avenue
San Carlos, CA 94070

STANDARD DRAWINGS		CADD FILE NO.:
STATIONS AND FACILITIES SIGNAGE		SD-3310
REV	DATE	
0	093011	
STATIONS & FACILITIES		
STATION IDENTIFIERS		STANDARD NO.:
		SD-3310